



# FLAT PANEL DOWNVIEW

Dimensions are for underneath side of worksurface. Product specifications are subject to change without notice. Dimensions are nominal. To offset your viewport and keyboard drawer, please call Customer Support at 1-800-730-6682 for special installation instructions.

## MAXIMUM DIMENSIONS & WEIGHT FOR FLAT PANEL DISPLAY (BASE EXCLUDED)

- FPA-0-1621: 20 1/8" W x 12 1/2" H (511mm x 318mm)
- FPA-0-1818: 17 1/8" W x 14 1/2" H (432mm x 368mm)
- FPA-0-1821: 20 1/8" W x 14 1/2" H (511mm x 368mm)
- FPA-0-2121: 20 1/8" W x 19" H (511mm x 482mm)
- FPA-0-2124: 22 1/2" W x 19" H (572mm x 482mm)

Weight of monitor cannot exceed 21 lbs.

Kit Model Number	Dimension C — Min. Work Surface Depth	Dimension D1 x Dimension D2 — View Port Cut-Out (W x D)
FPA-0-1621	24" (610 mm)	21 1/4" (540 mm) x 16 1/4" (413 mm)
FPA-0-1818	24" (610 mm)	18 1/4" (464 mm) x 18 1/4" (464 mm)
FPA-0-1821	24" (610 mm)	20 11/16" (526 mm) x 18 1/4" (464 mm)
FPA-0-2121	27 1/4" (692 mm)	21 1/4" (540 mm) x 21 1/4" (540 mm)
FPA-0-2124	27 1/4" (692 mm)	24 1/4" (616 mm) x 21 1/4" (540 mm)

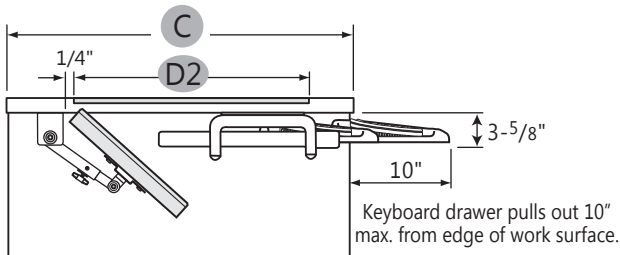

Refer to pricebook for keyboard availability with each kit.

Keyboard Size	Dimension A — Min. Kneespace Width	Dimension B — Keyboard Drill Pattern
24"	25 7/8" (657 mm)	22 19/32" (574 mm)
28"	29 1/2" (749 mm)	26 1/8" (663 mm)
30"	31 5/8" (803 mm)	28 1/16" (712 mm)
34"	35 1/2" (902 mm)	32 1/8" (815 mm)

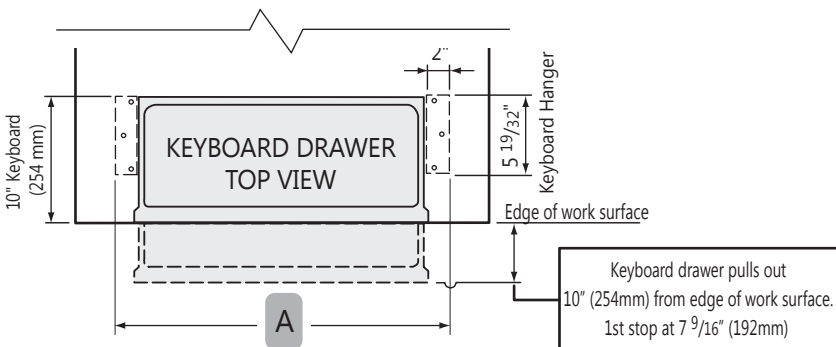

## VESA PLATE (100mm plate included)

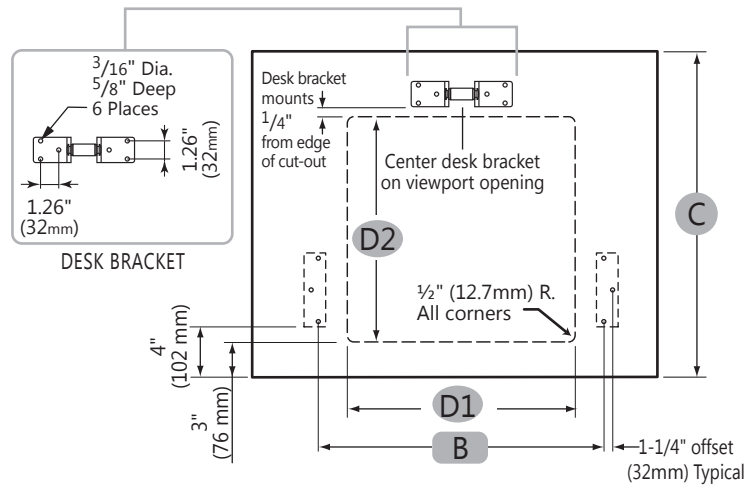
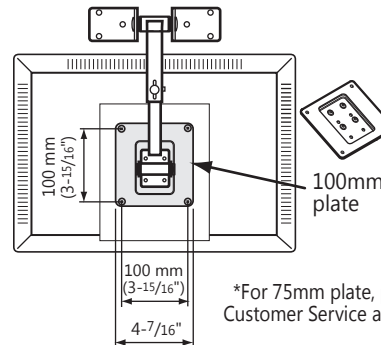

## FEATURES

### OPTIONAL VISOR

For unusual lighting situations, extra privacy, or to create the optimal level of viewing comfort, a textured black thermoformed ABS Visor is available for purchase. See pricebook for more information.

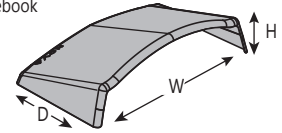

12" D x 26 1/2" W x 64" H

### GLASS

Tinted (T41 rating) and tempered with screen printed border and graphics.

Glass for FPA-0-1621:

16" D x 21" W x 1/4" H

Glass for FPA-0-1818:

18" D x 18" W x 1/4" H

Glass for FPA-0-1821:

18" D x 21" W x 1/4" H

Glass for FPA-0-2121:

21" D x 21" W x 1/4" H

Glass for FPA-0-2124:

21" D x 24" W x 1/4" H

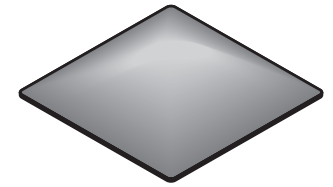

### TRIM RING

Manufactured using injection molded plastic, allowing support of view port.

Trim ring for FPA-0-1621:

16" D x 21" W x 1/4" H

Trim ring for FPA-0-1818:

18" D x 18" W x 1/4" H

Trim ring for FPA-0-1821:

18" D x 21" W x 1/4" H

Trim ring for FPA-0-2121:

21" D x 21" W x 1/4" H

Trim ring for FPA-0-2124:

21" D x 24" W x 1/4" H

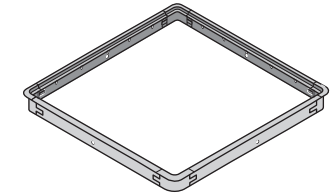

### FLAT PANEL ARM

Mounts underneath worksurface, supporting the flat panel display on a tension-mounted steel arm. The display attaches with a VESA compliant steel plate. Can be adjusted to fit fully-recessed or semi-recessed positions.

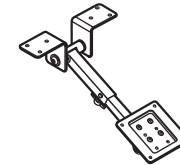

### KEYBOARD DRAWER

Textured black thermoformed ABS keyboard drawer features soft radius edges. Five positive inward and outward stop locations. Outward locking tabs prevent accidental removal of keyboard drawer.

