

Collaboration Tables

Technical Sales Brochure

Introducing NOVA Solutions' Collaboration Tables – a transformative solution designed to cultivate teamwork, innovation, and seamless communication in modern educational and professional environments.



46-CR919630CS



46-CT6011830CS-RWGSC



46-CD6018630CS-RWGSC



46-DT606030LB-RWGSC

Peripherals not included



(217) 342-7070

www.novadesk.com

sales@novasolutionsinc.com



Assembly required
for all products on
this page

Round Collaboration Tables

How to Order

1. Select model number

Ex: 46-CR919630CS (6 Seat Round Collaboration Table)

2. Select laminate base and worksurface color

Ex: 174 044
Base Worksurface

Optional Selections:

3. Select Visual Display Options

Ex: TE0728NK (The Trolley™ EXL with NOVA keyboard drawer)

4. Select Options and Factory Prepared Accessories

Ex: RWGSC (Star cut wire grommet)

Please Note:

Wire management system and power strip included per user

Model Number Structure

46	-	CR		919630		CS
Series		Type		Size		Type
		CR=Round Collaboration Table		D x W x H		CS=Standard
		CD=Boat Shape Collaboration Table				CX=No CPU
		CT=Keystone Collaboration Table				AD=With ADA Lift
						AX=ADA Lift, No CPU
						CT=With TV Lift
						AT=With ADA Lift & TV Lift
						CC=With TV Cabinet
						AC=ADA Lift & TV Cabinet

Visual Display Options

The Trolley™ Monitor Lift System

Maximum dimensions for widescreen:

E: 2 1/2" D x 18 7/8" W x 14 1/2" H (63.5mm D x 479.4mm W x 368.3mm H)

EXL: 2 1/2" D x 22 7/8" W x 14 1/2" H (63.5mm D x 581mm W x 368.3mm H)

NOTE: Maximum distance from center of wall mount VESA plate to bottom of monitor is 6 3/4" (171mm)

Available with  **NOVALinked™**

NOVALinked™ is a networking system that provides complete control of NOVA's Trolley™ monitor lifts in a classroom or training room setting.

Downview™

Maximum monitor dimensions:

16x21 widescreen viewport: 20 1/8" W x 12 1/2" H (511mm W x 318mm H)

18x21 widescreen viewport: 20 1/8" W x 14 1/2" H (511mm W x 368mm H)

Surface Mount Arm

Maximum monitor dimensions:

Surface Mount Arm: Up to 24" widescreen

Articulating Surface Mount Arm: Up to 35" widescreen

Maximum monitor weight:

Surface Mount Arm: 21 lbs

Articulating Surface Mount Arm: 33 lbs

Round Collaboration Tables

Available Visual Display Options: Trolley™ E (TE0724NK) or EXL (TE0728NK), Downview™ (FPA1621NK & FPA1821NK only), or Surface Mount Arm (SMA0203NK or ASMA0203NK)

5 Person Round Collaboration Table

Three-piece, 5 person table. Center laminate base. Includes Adjustable CPU Holder per user, adjusts from 4 1/4" to 7 1/2" wide

D x W x H (in.)	Seats	Model
93 1/4 x 95 1/2 x 30	5	46-CR949630CS

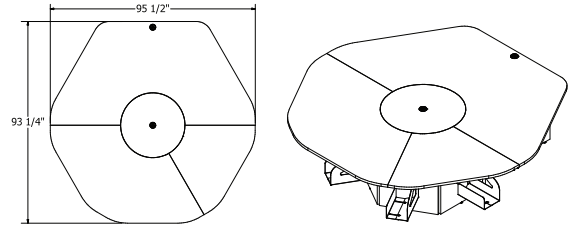

5 Person Round Collaboration Table with ADA Lift

ADA electric hydraulic lift option available for 1 user.

Electrically adjustable base height from 30" with 2 1/2" travel

D x W x H (in.)	Seats	Model
93 1/4 x 95 1/2 x 30	5	46-CR949630AD

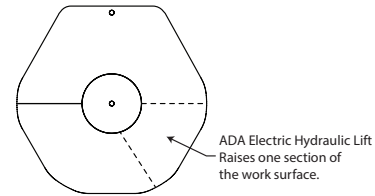

6 Person Round Collaboration Table

Three-piece, 6 person table. Center laminate base. Includes Adjustable CPU Holder per user, adjusts from 4 1/4" to 7 1/2" wide

D x W x H (in.)	Seats	Model
90 1/2 x 95 1/2 x 30	6	46-CR919630CS

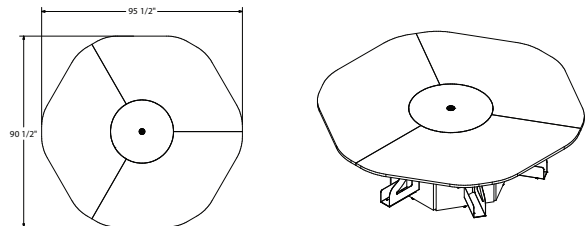

6 Person Round Collaboration Table with ADA Lift

ADA electric hydraulic lift option is available for 1 user.

Electrically adjustable base height from 30" with 2 1/2" travel

D x W x H (in.)	Seats	Model
90 1/2 x 95 1/2 x 30	6	46-CR919630AD

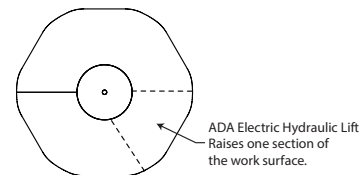



Assembly required
for all products on
this page

Boat Shape Collaboration Tables

Boat Shape Collaboration Tables

Available Visual Display Options:

Trolley™ E or EXL, Downview™ (FPA1621NK & FPA1821NK only), or Surface Mount Arm (SMA0203NK or ASMA0203NK)

4 Person Boat Shape Collaboration Table	CPU shelf width is 7". Two users on each side and one on the end. 6" D x 36" W compartment on opposite end for cables
D x W x H (in.)	Seats Model
60 x 83 15/16 x 30	4 46-CD608430CS

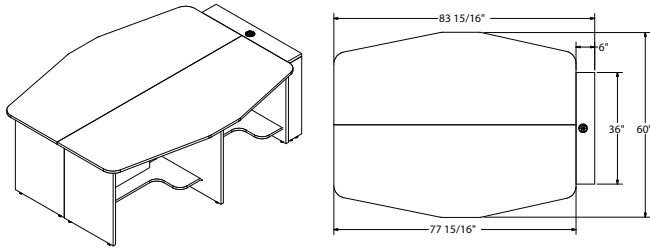

5 Person Boat Shape Collaboration Table	CPU shelf width is 7". Two users on each side and one on the end. 6" D x 36" W compartment on opposite end for cables
D x W x H (in.)	Seats Model
60 x 104 13/16 x 30	5 46-CD6010230CS

with ADA Lift

Electrically adjustable from 30" with 2 1/2" travel. Available for user on end only

60 x 104 13/16 x 30	5	46-CD6010230AD
---------------------	---	----------------

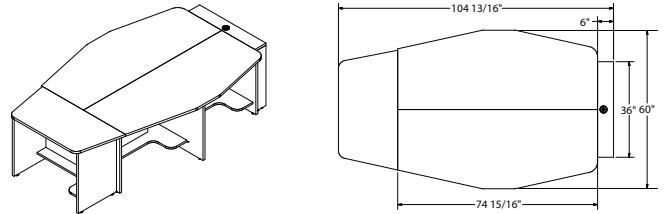

6 Person Boat Shape Collaboration Table	CPU shelf width is 7". Three users on each side. 6" D x 36" W compartment on end for cables
D x W x H (in.)	Seats Model
60 x 120 1/2 x 30	6 46-CD6011330CS

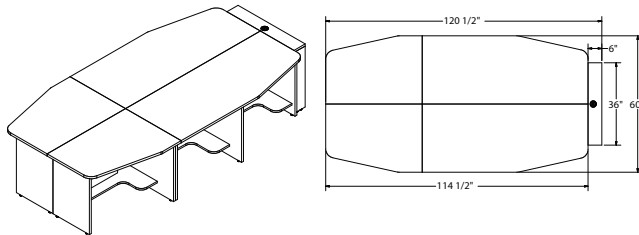

6 Person Boat Shape Collaboration Table	CPU shelf width is 7". Two users on each side and one on each end
D x W x H (in.)	Seats Model List Price
60 x 122 13/16 x 30	6 46-CD6012330CS

with ADA Lift

Electrically adjustable from 30" with 2 1/2" travel. Available for one user on end only

60 x 122 13/16 x 30	6	46-CD6012330AD
---------------------	---	----------------

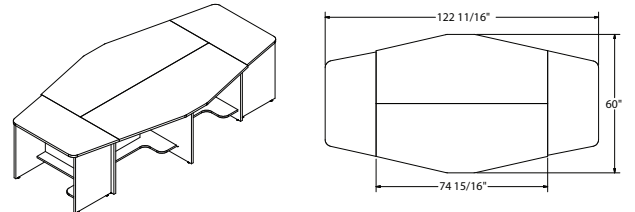

7 Person Boat Shape Collaboration Table	CPU shelf width is 7". Three users on each side and one on the end. 6" D x 36" W compartment on opposite end for cables
D x W x H (in.)	Seats Model
60 x 141 3/8 x 30	7 46-CD6013630CS

with ADA Lift

Electrically adjustable from 30" with 2 1/2" travel. Available for user on end only

60 x 141 3/8 x 30	7	46-CD6013630AD
-------------------	---	----------------

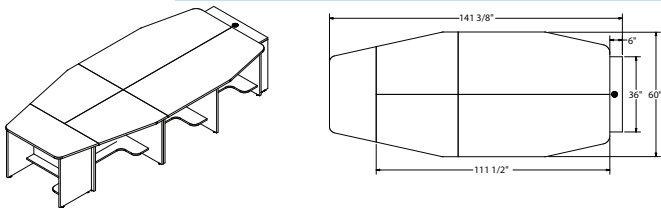

8 Person Boat Shape Collaboration Table	CPU shelf width is 7". Three users on each side and one on each end
D x W x H (in.)	Seats Model
60 x 159 1/4 x 30	8 46-CD6015230CS

with ADA Lift

Electrically adjustable from 30" with 2 1/2" travel. Available for one user on end only

60 x 159 1/4 x 30	8	46-CD6015230AD
-------------------	---	----------------

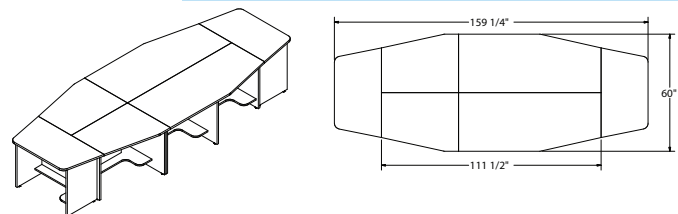

10 Person Boat Shape Collaboration Table	CPU shelf width is 7". Four users on each side and one on each end
D x W x H (in.)	Seats Model
60 x 194 13/16 x 30	10 46-CD6018630CS

with ADA Lift

Electrically adjustable from 30" with 2 1/2" travel. Available for one user on end only

60 x 194 13/16 x 30	10	46-CD6018630AD
---------------------	----	----------------

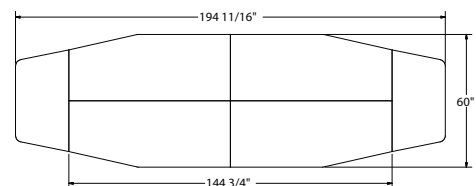
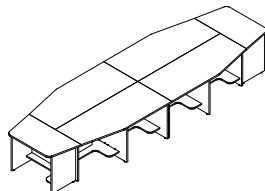



Assembly required
for all products on
this page

Keystone Collaboration Tables

Keystone Collaboration Tables

Available Visual Display Options:

Trolley™ E or EXL, Downview™ (FPA1621NK & FPA1821NK only), or Surface Mount Arm (SMA0203NK or ASMA0203NK)

4 Person Keystone Collaboration Table	CPU shelf width is 7". Two users on each side. 6" D x 36" W compartment on end for cables		
	D x W x H (in.)	Seats	Model
	60 x 82 x 30	4	46-CT608230CS

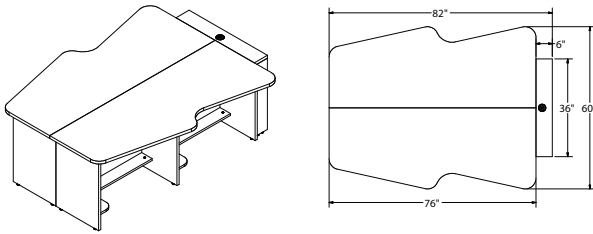

5 Person Keystone Collaboration Table	CPU shelf width is 7". Two users on each side and one on the end. 6" D x 36" W compartment on opposite end for cables		
	D x W x H (in.)	Seats	Model
	60 x 102 7/8 x 30	5	46-CT6010230CS

with ADA Lift

Electrically adjustable from 30" with 2 1/2" travel. Available for user on end only

60 x 102 7/8 x 30	5	46-CT6010230AD
-------------------	---	----------------

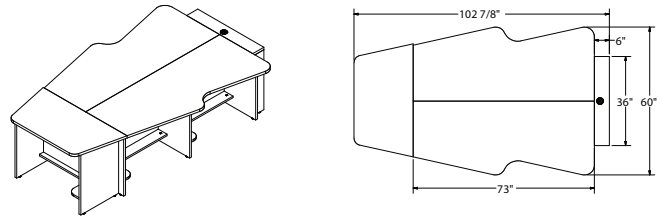

6 Person Keystone Collaboration Table	CPU shelf width is 7". Three users on each side. 6" D x 36" W compartment on end for cables		
	D x W x H (in.)	Seats	Model
	60 x 119 1/16 x 30	6	46-CT6011830CS

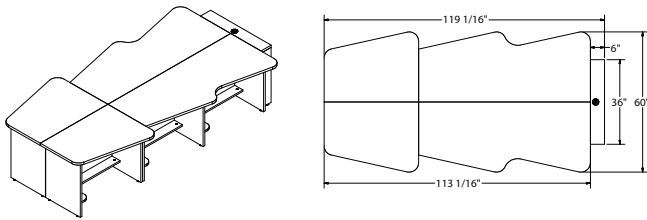

7 Person Keystone Collaboration Table	CPU shelf width is 7". Three users on each side and one on the end. 6" D x 36" W compartment on opposite end for cables		
	D x W x H (in.)	Seats	Model
	60 x 139 15/16 x 30	7	46-CT6014230CS

with ADA Lift

Electrically adjustable from 30" with 2 1/2" travel. Available for one user on end only

60 x 139 15/16 x 30	7	46-CT6014230AD
---------------------	---	----------------

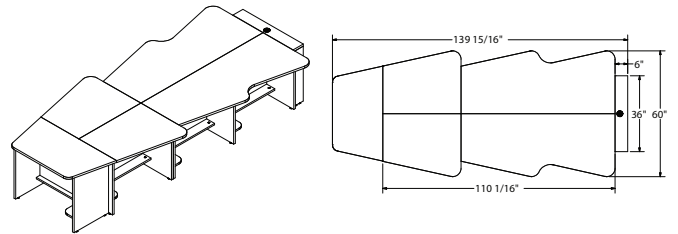

8 Person Keystone Collaboration Table	CPU shelf width is 7". Four users on each side. 6" D x 36" W compartment on end for cables		
	D x W x H (in.)	Seats	Model
	60 x 155 x 30	8	46-CT6015630CS

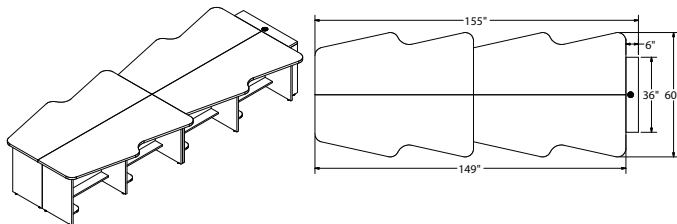

10 Person Keystone Collaboration Table	CPU shelf width is 7". Five users on each side. 6" D x 36" W compartment on end for cables		
	D x W x H (in.)	Seats	Model
	60 x 192 1/16 x 30	10	46-CT6019230CS

with ADA Lift

Electrically adjustable from 30" with 2 1/2" travel. Available for one user on end only

60 x 192 1/16 x 30	11	46-CT6021430AD
--------------------	----	----------------

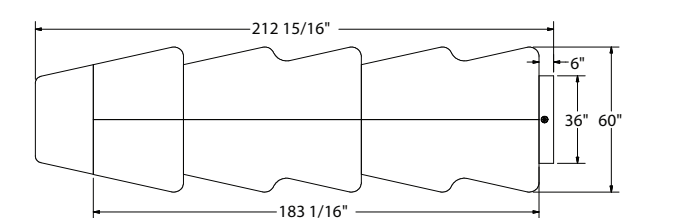

11 Person Keystone Collaboration Table	CPU shelf width is 7". Five users on each side and one on the end. 6" D x 36" W compartment on opposite end for cables		
	D x W x H (in.)	Seats	Model
	60 x 212 15/16 x 30	11	46-CT6021430CS

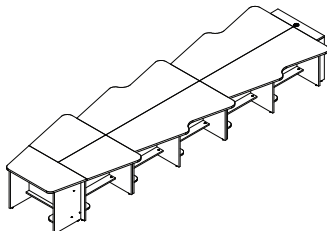



Assembly required
for all products on
this page

D-Top Collaboration Tables

How to Order

1. Select model number

Ex: 46-DT486030LB

2. Select laminate base and worksurface color

Ex: **174** **044**
Base Worksurface

Optional Selections:

3. Select Options and Factory Prepared Accessories

Ex: 11225PP (Pop-up Power Center)

Please Note:

Not available with Visual Display Options. Wire management system included in central iMod™ compartment

Model Number Structure

46

Series

- **DT**

Type

DT=D-Top Collaboration Table

486030

Size

D x W x H

LB

Type

LB=Standard Base
LT=Standard Base with TV Lift
LC=Standard Base with TV Cabinet
RLB=Rack Cabinet Base
RLT=Rack Cabinet Base w/ TV Lift
RLC=Rack Cabinet Base w/ TV Cabinet

D-Top with Standard Base

Center iMod™ with removable modesty panel on one side

4 Person D-Top Collaboration Table	D x W x H (in.)	Seats	Model
	48 x 60 x 30	4	46-DT486030LB
	60 x 60 x 30	4	46-DT606030LB

6 Person D-Top Collaboration Table	D x W x H (in.)	Seats	Model
	48 x 84 x 30	6	46-DT488430LB
	60 x 84 x 30	6	46-DT608430LB

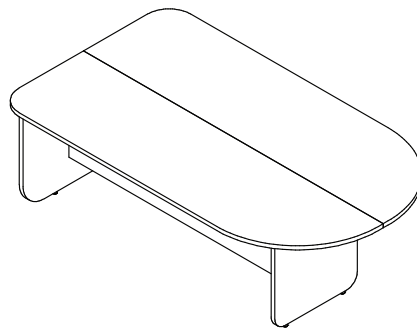
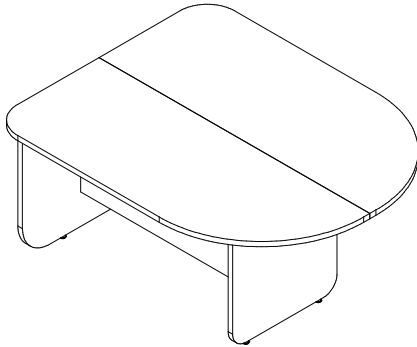

D-Top with Rack Cabinet Base

Rack Cabinet included on wide end of table with front and rear locking modesty panels. Power strip included in Rack Cabinet.
10 RU Rack Storage. Storage width: 19 1/4"

4 Person D-Top Collaboration Table with Rack Cabinet	D x W x H (in.)	Seats	Model
	48 x 60 x 30	4	46-DT486030RLB
	60 x 60 x 30	4	46-DT606030RLB

6 Person D-Top Collaboration Table with Rack Cabinet	D x W x H (in.)	Seats	Model
	48 x 84 x 30	6	46-DT488430RLB
	60 x 84 x 30	6	46-DT608430RLB

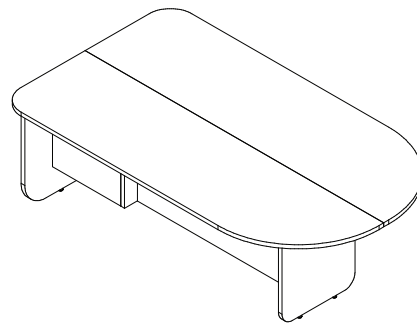
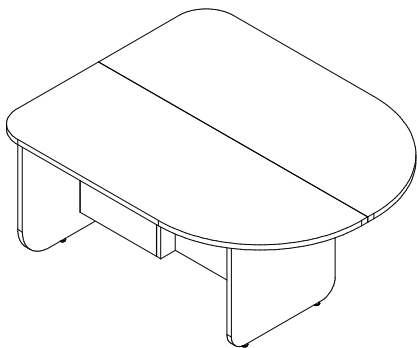



Assembly required
for all products on
this page

Options & Accessories

Collaboration Table Options

Not available with Conference Tables

TV Lift

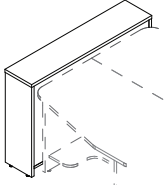

Dimensions	Model
Electric motor lift raises TV from enclosed laminate end storage cabinet to usable height.	
<ul style="list-style-type: none"> To add TV Lift change last position of model number to "T" Ex: 46-CD6010230CS would become 46-CD6010230CT Power strip included in TV Lift cabinet Note: Only available on units with end wire compartment and D-Top Collaboration Tables 	
10 5/8" D x 48" W x 32 7/8" H	

TV Cabinet

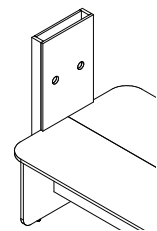

Laminate Cabinet for mounting TV onto Collaboration Table with concealed wire management.	
<ul style="list-style-type: none"> To add TV Cabinet change last position of model number to "C" Ex: 46-DT486030RLB would become 46-DT486030RLC Fits most screens 37" - 70". Max weight 165 lb. Note: Only available on units with end wire compartment and D-Top Collaboration Tables 	
4 3/8" D x 20" W x 57 3/8" H	

TV Mounting Pole

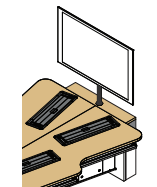

TV Mounting Pole with 100mm or 400mm VESA mount pattern	
<ul style="list-style-type: none"> Field installed item Note: Only compatible with units with end wire compartment 	
100mm VESA	AC-TMP100
400mm VESA	AC-TMP400

Factory Prepared Accessories

Must specify location of grommet / power center at time of order

Factory Prepared NOVA Keyboard Drawer

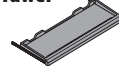

D x W x H (in.)	Model
Keyboard length to fit desk ordered. Only ordered when NO Visual Display Option is chosen.	
	NK

Rectangular Wire Grommet



Rectangular black plastic grommet cover is removable for easy wire management	
1 7/8" D x 3 1/4" W	WG1080

Star Cut Wire Grommet



Round black plastic grommet with rubber star cut opening allows more cords and cables to pass through.	
2 3/4" Diameter	RWGSC

Pop-up Power Center



Two grounded outlets. Fluid one touch accessibility. 6ft, 15 Amp cord. UL listed.	
3 3/4" D x 5" W	11225PP

Pop-up Power / Data Center



One grounded outlet. One opening for voice/data jack. Voice/Data Adapter Kit (included) provides adapters for couplers & jacks from a variety of manufacturers. Fluid one touch accessibility. 6ft, 15 Amp cord. UL listed.	
3 3/4" D x 5" W	11225PD

Pop-up Power / USB Charging Center



One grounded outlet. One USB charging duplex. Fluid one touch accessibility. 6ft, 15 Amp cord. UL Listed.	
3 3/4" D x 5" W	11225PC

Round Flush Power Center



Two grounded outlets. Clean, flush mount. 6ft, 15 Amp cord. UL listed.	
4" Diameter	3359PP

Round Flush Power / USB Charging Center



One grounded outlet. One USB charging duplex. Clean, flush mount. 6ft, 15 Amp cord. UL Listed.	
4" Diameter	3359PC

Round Power Center



One grounded outlet. Features spill-proof technology. 6ft, 15 Amp cord. UL Listed.	
2" Diameter	3825P



Assembly required
for all products on
this page

Visual Display Options

One (1) Visual Display Option per user in collaboration table ordered

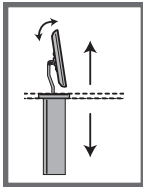

The Trolley™

- Ships installed in most units
- Maximum distance from center of wall mount VESA plate to bottom of monitor is 6 3/4" (171mm)

The Trolley™ E

Maximum Dimensions for Widescreen:
2 1/2" D x 18 7/8" W x 14 1/2" H
up to 20" widescreen

The Trolley™ EXL

Maximum Dimensions for Widescreen:
2 1/2" D x 22 7/8" W x 14 1/2" H
up to 24" widescreen

- Patented Access door automatically opens and closes with the push of a button
- Low voltage electrical motor to lift & lower monitor
- Intelligent Motion Technology™ provides operational intuition

Model	Wt(lbs)	Description
-------	---------	-------------

With NOVA Keyboard Drawer

NOVA Keyboard Drawer installed in assembled units only.

International Customers: The Trolley™ includes Universal Power Control Units, compatible with all power requirements inside and outside the U.S.

TE0724NK	48	Trolley™ E & NOVA Keyboard Drawer
----------	----	-----------------------------------

TE0728NK	48	Trolley™ EXL & NOVA Keyboard Drawer
----------	----	-------------------------------------

Available with **NOVA Linked™**

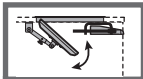

Downview™

- Installation required

16" D x 21" W viewport (Widescreen)

Maximum Dimensions for Widescreen: 20 1/8" W x 12 1/2" H
up to 21" widescreen

24" min. worksurface depth

18" D x 21" W viewport (Widescreen)

Maximum Dimensions for Widescreen: 20 1/8" W x 14 1/2" H
up to 21" widescreen

26" min. worksurface depth

- Tinted, tempered glass viewport
- Keeps monitor under glass below worksurface
- Ergonomic viewing angle

Model	Wt(lbs)	Description
-------	---------	-------------

With NOVA Keyboard Drawer

Downview™ & NOVA Keyboard Drawer installed in assembled units only.

Optional Privacy/Glare visor sold separately

FPA1621NK	35	16" D x 21" W Downview™ & NOVA Keyboard Drawer
-----------	----	--

FPA1821NK	35	18" D x 21" W Downview™ & NOVA Keyboard Drawer
-----------	----	--

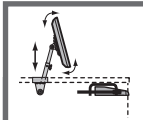

Surface Mount Arm

- Installation required

Surface Mount Arm

Maximum Weight: 21 lbs
Maximum Dimensions: Up to 24" widescreen

Articulating Surface Mount Arm

Maximum Weight: 33 lbs
Maximum Dimensions: Up to 35" widescreen

- Securely fastens monitor to worksurface
- Height and tilt adjustable

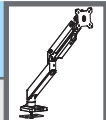

Model	Wt(lbs)	Description
-------	---------	-------------

With NOVA Keyboard Drawer

NOVA Keyboard Drawer installed in assembled units only.

SMA0203NK	13	SMA & NOVA Keyboard Drawer
-----------	----	----------------------------

ASMA0203NK	22	Articulating SMA & NOVA Keyboard Drawer
------------	----	---